

CROSS-SHORE DISTRIBUTION OF SEDIMENT TEXTURE UNDER BREAKING WAVES ALONG LOW-WAVE-ENERGY COASTS

PING WANG¹, RICHARD A. DAVIS, JR.², AND NICHOLAS C. KRAUS³

¹ Coastal Studies Institute, Louisiana State University, Baton Rouge, Louisiana 70803, U.S.A.

² Department of Geology, University of South Florida, Tampa, Florida 33620, U.S.A.

³ U.S. Army Engineer Waterways Experiment Station, Coastal and Hydraulics Laboratory, 3909 Halls Ferry Road, Vicksburg, Mississippi 39180, U.S.A.

ABSTRACT: Sediment samples were collected with streamer traps at different elevations in the water column and across the surf zone. Beach profiles and breaking waves were measured together with the sediment sampling. The experiments were conducted on beaches with various sediment composition ranging from well-sorted fine sand to poorly sorted gravel and shell debris. The cross-shore variation of sediment mean grain size ranged from less than 1 ϕ to significant variation of up to 3.5 ϕ . The resultant database contains 99 vertical grain-size profiles, composed of 99 bottom samples and 552 trap samples taken throughout the water column and at 29 different locations along the southeast coast of the United States and the Gulf coast of Florida.

A homogeneous vertical profile of mean grain size and grain-size distribution pattern was found on most of the beaches with a wide range of sediment sizes. The homogeneous vertical profile, representing 92% of the measurements, was found on all morphological features: swash zone, breaker line, mid-surf zone, trough, and bar. A homogeneous distribution indicates that the vertical mixing mechanism in the water column of the surf zone is independent of sediment size ranging from fine sand to fine pebbles. Bottom sediment, represented by an 8-cm core sample, was generally coarser than the sediment trapped in the water column.

INTRODUCTION

The distribution of grain size under breaking waves and across the surf zone is fundamental for understanding sediment-transport processes and beach-morphology change. Information on the cross-shore and vertical distributions of grain size also enters engineering applications, such as determining compatibility of beach nourishment material and designing of coastal structures to hold sand. Although there have been a large number of studies on the concentration of suspended sediment in the nearshore zone (e.g., Fairchild 1977; Kana 1979; Nielsen 1984; Zampol and Inman 1989; Zampol and Waldorf 1989; Greenwood et al. 1991; Barkaszi and Dally 1992; Hay and Sheng 1992; Crawford and Hay 1993), only a few studies have addressed the vertical grain-size distribution of the suspended sediment (Kana 1979; Kennedy et al. 1981; Kraus et al. 1988; Hay and Sheng 1992), and these studies were conducted on beaches composed of fairly well-sorted fine sands with little cross-shore variation in either mean grain size or grain-size distribution.

Conventional suspended-sediment sampling has relied on mechanical pumping and suction techniques (e.g., Watts 1953; Fairchild 1965, 1977; Nielsen 1984). These techniques were mostly used outside the surf zone with sampling duration of several minutes, which averaged about 20 to 100 waves. These samplers generally collect sediment and water at the same time, resulting in a simultaneous measurement of sediment concentration during the sampling. Application of pumping and suction techniques inside the surf zone is difficult because of high wave energy, significant air entrapment, large sediment size, and great variation in water depth.

Several instantaneous sampling techniques that are capable of sampling a certain phase of wave motion have been developed (e.g., Kana 1979; Zampol and Inman 1989) and have been used mostly inside the surf zone. Instantaneous sampling provides information on sediment suspension events during wave breaking, but it is not capable of obtaining represen-

tative average values, and the amount of sediment collected, usually less than 1 g, may not be sufficient to obtain a reliable grain-size distribution for poorly sorted sediment.

The optical and acoustical techniques developed by Hay and Sheng (1992) and Crawford and Hay (1993) are capable of estimating vertical profiles of sediment concentration and mean grain size simultaneously with much higher temporal and spatial resolutions than the pumping, suction, and trapping techniques. Application of the promising acoustic (Hay and Sheng 1992) and laser (Agrawal et al. 1996) techniques inside the surf zone is currently limited by several factors, including: (1) harsh environmental conditions caused by high wave energy; (2) significant amount of air bubbles in the water column; (3) large sediment particles in suspension; (4) difficulty in obtaining near-bed (e.g., < 5 cm) measurements; and (5) high cost.

Nielsen (1983, 1991) found that the mechanisms that distribute sediment in the water column were different for different-sized sediments. He concluded that the vertical distribution of fine sediment under nonbreaking waves tends to be governed by diffusive mechanisms, whereas the convective mechanism plays a more important role for the coarser fraction.

In the present study, 99 bottom and 552 suspended sediment samples obtained throughout the water column were collected in the surf zone using the streamer-trap technique (Kraus 1987). The field-data collection was conducted on both barred and non-barred coasts composed of a variety of sediment textures ranging from well-sorted fine quartz sand to poorly sorted shelly sand and gravel.

The objectives of this study were to: (1) characterize the grain-size distribution of sediment at different elevations in the water column across the surf zone under breaking waves; (2) compare the vertical distribution patterns using data collected from beaches with very different sediment textures; and (3) investigate selective transport through size and shape comparison between bottom sediment and sediment in motion. To meet these objectives, a labor-intensive sediment trap method was used.

STUDY AREAS

Field data were collected at 29 sites along the southeast coast of the United States and the Gulf coast of Florida (Fig. 1) from September 1993 to May 1995. The field sites were selected to cover a wide range of morphodynamic and hydrodynamic conditions. Seven (24%) of the 29 experiments were conducted on barred coasts with waves breaking on the bar, and 18 (62%) were conducted on coasts with negligible offshore bar influence on wave breaking. Four (13%) measurements were made only in the inner surf on barred coasts, owing to operational difficulties caused by high waves and a deep trough. Twelve field sites had a plunge step at the breaker line or secondary breaker line for the barred coasts.

Wave conditions and general sediment properties at the 29 field sites are summarized in Table 1. Surf-zone width ranged from as narrow as 1 m at one of the Florida Panhandle sites to more than 54 m at Redington Beach, Florida, toward the end of a winter storm. The average measured surf zone width was 14 m with a standard deviation of 13 m, indicating a broad distribution.

The sediment sampling was conducted under a variety of hydrodynamic conditions (Table 1). Root-mean-square (rms) wave height, calculated on the basis of the 20 measured wave heights from video images (e.g., Hori-

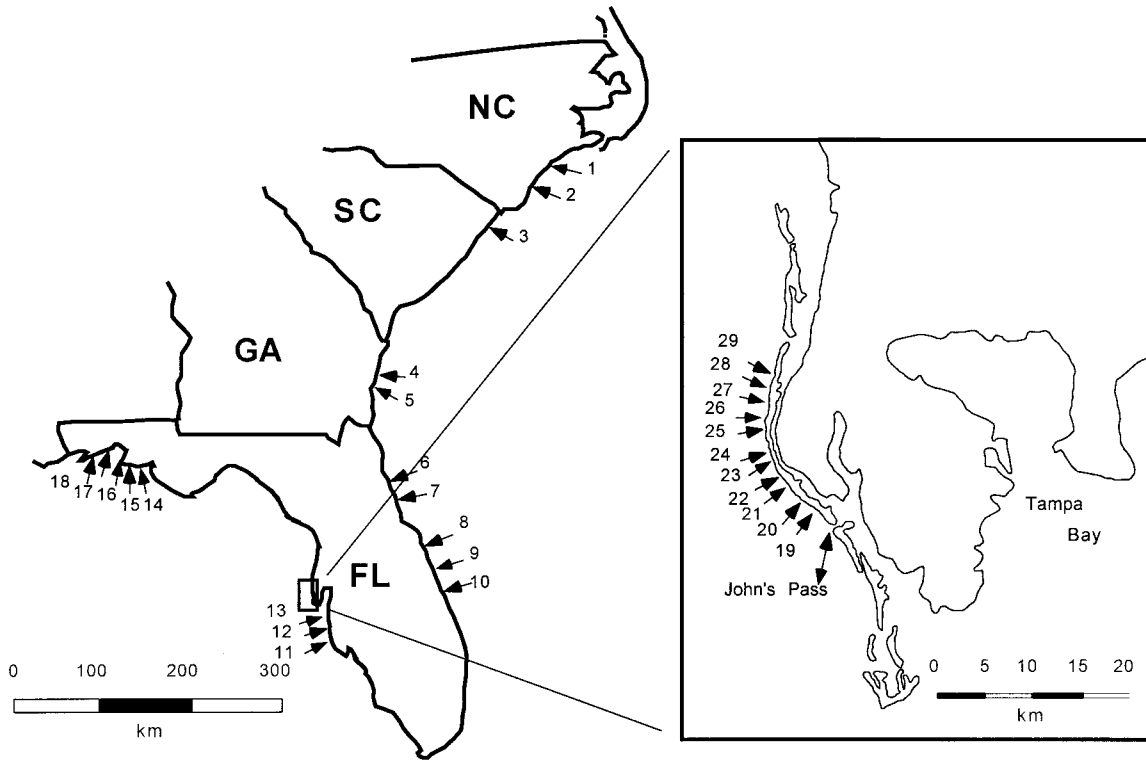

FIG. 1.—Locations of the field experiments and site ID (site ID numbers are given in Table 1).

TABLE 1.—Summary of hydrodynamic and morphodynamic conditions at the field sites.

Location & Site ID (Fig. 1)	No. of Trap Arrays	Surf Zone Width (m)	Cross-Shore GS Variation ϕ^1	Avg. Grain Size ³ mm (ϕ)	Breaker Height H_{rms} (m)	Incident Wave Angle ($^\circ$)	Wave Period (s)
1. Emerald Isle, NC	4	35	0.6	0.35 (1.51)	0.79	13.5	7.5
2. Onslow Beach, NC	3	7 ²	3.5	2.25 (-1.17)	0.61	12.0	6.0
3. Myrtle Beach, SC	5	24	1.0	0.26 (1.94)	0.51	4.0	8.5
4. Jekyll Island, GA	2	9	0.0	0.17 (2.56)	0.20	3.0	3.5
5. Jekyll Island, GA	3	14	0.3	0.26 (1.94)	0.35	10.0	3.3
6. Anastasia Beach, FL	6	36	0.2	0.19 (0.49)	0.49	5.5	10.5
7. N. Mantanzas Beach, FL	3	14	0.5	0.28 (0.44)	0.44	7.2	7.2
8. Canaveral Seashore, FL	3	6 ²	0.7	0.90 (0.46)	0.46	9.0	3.5
9. Melbourne Beach, FL	2	4 ²	2.1	1.50 (-0.58)	0.50	2.5	3.5
10. Beverly Beach, FL	2	3 ²	1.1	0.41 (1.29)	0.36	11.5	3.5
11. Lido Key Beach, FL	4	38	1.6	0.68 (0.56)	0.38	14.0	3.7
12. Lido Key Beach, FL	5	35	3.0	0.54 (0.89)	0.34	19.0	3.4
13. Lido Key Beach, FL	4	21	2.3	0.37 (1.43)	0.21	2.6	3.0
14. St. George Island, FL	3	3	0.2	0.29 (1.79)	0.29	35.3	3.0
15. St. George Island, FL	4	4	0.2	0.41 (1.29)	0.22	31.5	2.9
16. St. George Island, FL	3	2	0.3	0.43 (1.22)	0.28	23.0	3.0
17. St. Joseph Island, FL	4	10	0.3	0.24 (2.06)	0.53	9.3	4.2
18. Grayton Beach, FL	4	29	0.4	0.28 (1.84)	0.56	8.5	4.5
19. Redington Beach, FL	3	4	0.7	0.85 (0.23)	0.36	8.4	4.5
20. Redington Beach, FL	3	11	0.2	0.20 (2.32)	0.28	10.7	3.9
21. Redington Beach, FL	4	19	3.0	0.90 (0.15)	0.32	19.2	4.5
22. Redington Beach, FL	4	17	2.2	0.43 (1.22)	0.24	15.8	4.9
23. Redington Beach, FL	4	54	2.2	0.37 (1.43)	0.69	13.1	7.3
24. Indian Shores, FL	3	12	0.9	0.32 (1.64)	0.36	20.0	4.5
25. Indian Shores, FL	1	4	—	0.40 (1.32)	0.31	1.8	3.3
26. Indian Rocks Beach, FL	2	4	2.6	0.28 (1.84)	0.36	7.7	2.9
27. Indian Rocks Beach, FL	3	7	1.1	0.42 (1.25)	0.34	7.5	4.2
28. Indian Rocks Beach, FL	2	2	1.2	1.38 (-0.46)	0.19	10.0	2.8
29. Indian Rocks Beach, FL	2	2	1.2	1.29 (-0.37)	0.14	8.2	3.8

SUMMARY

Range	1-6	2-54	0.0-3.5	0.17-2.25	0.14-0.79	1.8-35.3	2.8-10.5
Average	3.3	14.8	1.2	0.57	0.38	11.9	4.5

¹ Difference between the coarsest and finest bottom sediment sampled across the surf zone.

² Number indicates width of the inner surf zone, unable to perform trapping in the trough or on the bar because of rough conditions.

³ Average of the surface samples collected at each trap location.

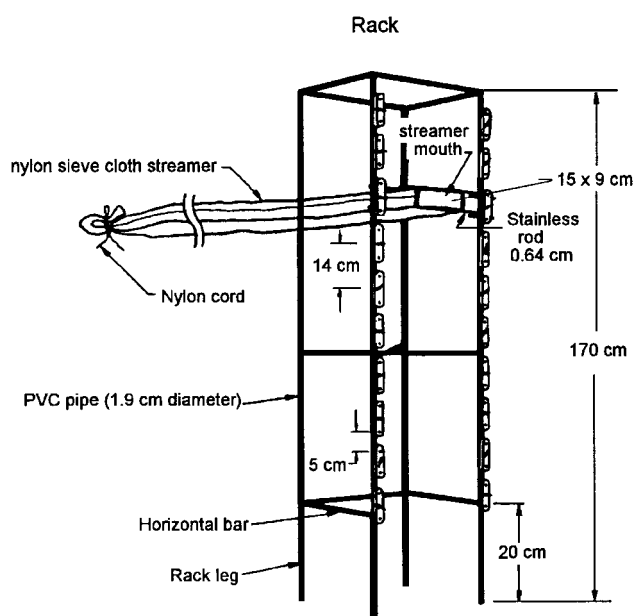

FIG. 2.—Design of the streamer traps (modified from the design of Kraus 1987).

kawa 1988; Kraus et al. 1989), ranged from 0.1 to 0.8 m, representing relatively low-wave-energy conditions (Davis 1996). Sediment samples were collected under plunging, spilling, and collapsing breakers. Incident wave angle as judged visually ranged from 2° to 35° . The extreme oblique wave angle was measured in the Florida Panhandle where the waves are small and are generated mainly by local winds. Wave period ranged from less than 3 s for locally generated seas in the Gulf of Mexico to more than 10 s for swells along the Atlantic coast.

Sediment properties varied from beach to beach as well as from one part of a beach to another. The average bottom sediment grain size of the selected beaches, which was obtained by averaging the three to six bottom sediment samples, ranged from 0.17 mm (2.55ϕ) to 2.25 mm (-1.17ϕ). Sediment mean grain size also varied significantly in different parts of the same surf zone at any given time. The difference could be as large as 3.7 mm (4.06 mm at the breaker line and 0.35 mm in the trough; Site 2, Fig. 1).

One of the unique features of the sediment composing many of the studied beaches, particularly along the Florida coast, is the high concentration of shell debris from bivalves. The shell debris, especially in the fractions larger than medium sand, was typically platy. The shell content was measured by the percent carbonate concentration in the sediment samples. The rest of the sediment was composed mainly of spherical quartz grains. The platy shell debris behaves differently in terms of settling path and velocity than the spherical grains (e.g., Komar and Reimers 1978; Mehta et al. 1980). The shape of surf-zone sediment indicated by the concentrations of platy shell debris varied from beach to beach as well as in different parts of the same surf zone, similarly to the mean grain size.

METHODOLOGY

Standard field and laboratory procedures were established and followed to ensure that the data were collected and analyzed in the same manner (Wang 1995). The streamer sediment traps used in this study (Fig. 2) are similar to the design of Kraus (1987) except that the racks are made from PVC pipe instead of stainless steel rod. PVC pipe is inexpensive and easier to construct, and it has proved to work well in the low-energy settings (Wang and Davis 1994; Wang 1995). The legs of the rack were shortened for easy operation and increased near-bed trapping efficiency.

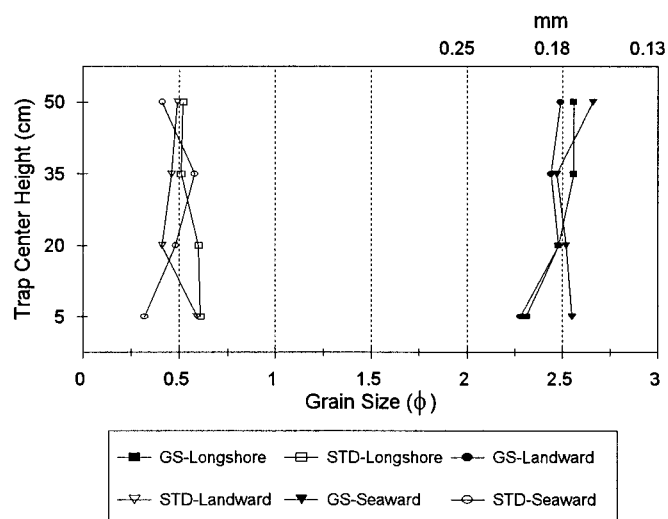

FIG. 3.—An example of the directional sensitivity of streamer-trap sampling. The identical mean grain size and standard deviation indicate that the along-shore moving sediment represents the sediment in the water column. The sample was taken at breaker line at Indian Rocks Beach, Florida.

The opening of the streamer is 15 cm wide and 9 cm high, and the distance between two adjacent streamer bags is 6 cm. The mesh size of the sieve cloth from which the streamers are made is $63 \mu\text{m}$. Mesh size is not considered to introduce sampling error because mud is essentially absent from the surf zones studied. Streamer bags of different lengths were deployed at different elevations in the water column: longer bags (~ 120 cm) were mounted at the bottom three levels and shorter bags (~ 70 cm) were mounted at the higher levels. This design allowed good coverage throughout the water column, easy assembly, and efficient field sediment sampling.

Four to eight streamer bags were mounted on each rack as determined by the water depth and breaker height. This assemblage is called one trap array. A typical sediment sampling experiment involved deployment of three to six streamer-trap arrays across the surf zone (Table 1). Beach profiles were surveyed using a SOKKIA SET 4B electronic total station. The sampling locations across the surf zone were recorded during the beach profile survey.

A bottom sediment sample was collected at each trap location. It is assumed that the average bottom sediment characteristics can be represented by a core sample 8 cm long. The sediments at different depth levels were sampled simultaneously by the streamer traps. Most of the sediment sampling was conducted with the trap opening facing into the longshore transport. Similar sampling orientation was used by numerous previous pumping and suction studies (e.g., Watts 1953; Fairchild 1965; Coakley et al. 1978; Nielsen 1983). In contrast to generating a high-velocity artificial flow through a small opening (typically in the order of millimeters) as do most pumping and suction techniques, the streamer trap takes advantage of the longshore current generated by obliquely incident waves or other forcing mechanism to transport sediment into the trap. The trap openings are large enough to allow large sediment particles (up to 2 cm in diameter, as collected in some samples) to enter the streamer freely. However, the large openings reduce vertical resolution. Rosati and Kraus (1988) established the hydraulic efficiency of the streamer as being close to unity. Also, as opposed to pumping and suction, instantaneous sampling, and remote sensing techniques, the streamer trap measures the longshore sediment flux instead of sediment concentration during the sediment sampling.

The placement strategy of the streamer traps in the surf zone depended on the morphological and hydrodynamic conditions. Typical placement of trap arrays for a barred coast was one trap array on top of the bar, one in

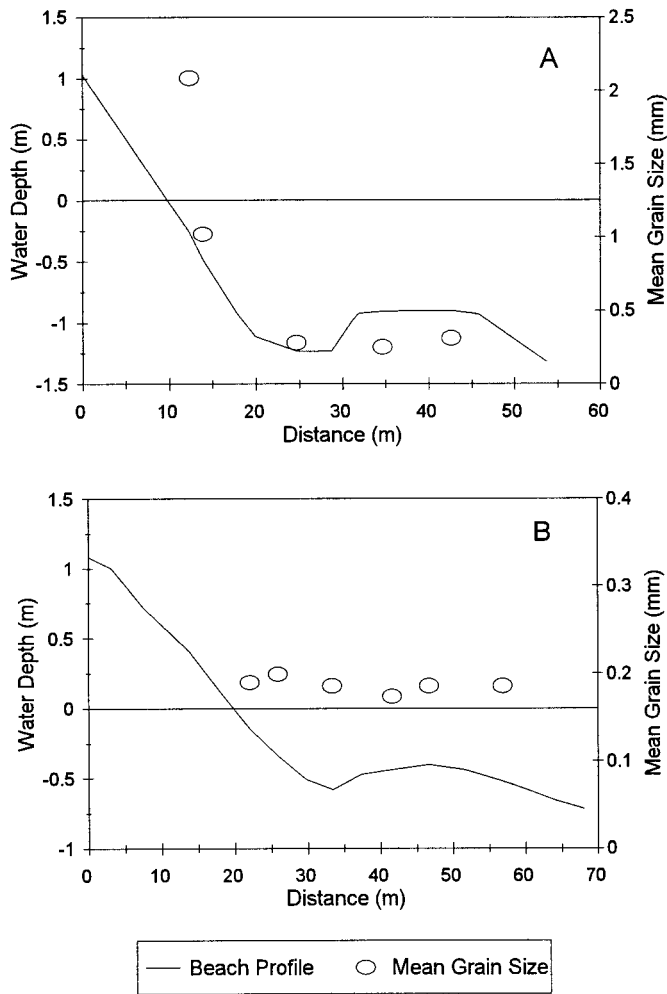

Fig. 4.—Examples of cross-shore distribution of sediment mean grain size. **A)** large cross-shore variation: Lido Key, Florida (Site 12, Fig. 1); and **B)** uniform distribution with negligible cross-shore variation, Anastasia, Florida (Site 6, Fig. 1).

the trough, one at the secondary breaker line, and one in the swash. On a nonbarred coast, the common arrangement was one trap at the breaker line, at least one in the surf bore area, and one in the swash. The objective was to collect sediment samples under different hydrodynamic regimes on various morphological features.

The trapping duration was determined on the basis of the magnitude of longshore sediment transport rate and trapping conditions. The duration was typically 5 min, ranging from 3 to 10 min, similar to those of Nielsen (1983) and Hay and Sheng (1992). Therefore, the measured values represent the average of about 30 to 100 waves depending on the wave period. Seven sets of sediment sampling runs were performed with the trap opening facing landward and/or seaward. The cross-shore-facing experiments were conducted at different locations in the surf zone at Redington Beach (Site 21, Fig. 1) and Indian Rocks Beach (Site 27, Fig. 1), Florida. The objective was to test the influence of trap orientation on the sediment sampling. The trapping duration for the cross-shore orientation was 2.5 min. Mean grain size and standard deviation of the trapped sediment that was moving alongshore, onshore, and offshore are shown in Figure 3. The similar grain size throughout the water column indicates that the properties of the sediment throughout the water column can be represented by the sediment sampled alongshore. The following discussion is based on the sediment samples from the longshore-directed transport.

One of the advantages of the streamer-trap technique is that large

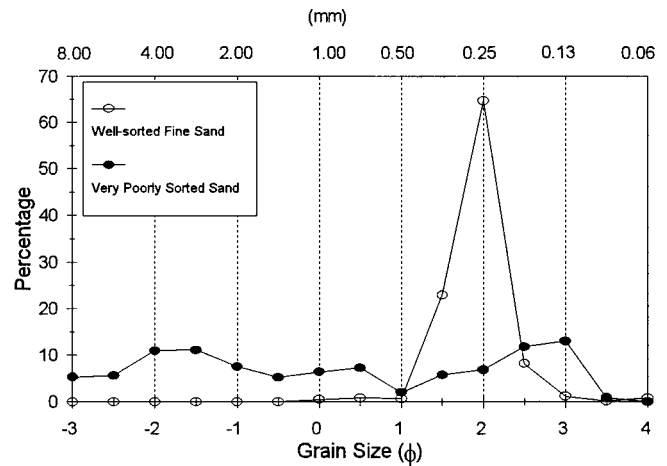

Fig. 5.—Two end members of the grain-size distribution patterns: well-sorted fine sand from Grayton Beach, Florida (Site 18, Fig. 1) and very poorly sorted shelly sand from Indian Rocks Beach, Florida (Site 28, Fig. 1).

amounts of sediment can be collected within a short period of time, in this case, 3 to 10 min. Typically, 5 to 6000 g of sediment were trapped depending on elevation in the water column, strength of the longshore current, and local wave activity. The amount of trapped sediment, i.e., the longshore sediment flux, decreased logarithmically upward in the water column (Wang 1998), as also found by Kraus et al. (1988) and Rosati et al. (1991b). A nonnegligible amount of sediment was trapped even above the mean water level, especially in the swash zone and at breaker line, as first reported by Kraus et al. (1988). The sediment captured above the mean water level was brought into the traps in the wave crests. A reliable profile of time-averaged grain-size distribution throughout the water column can be obtained even for the poorly sorted gravel sand because of the large amount of sediment collected.

Mean grain size and standard deviation of the 651 sediment samples were calculated using the conventional method of moments, using the unit of ϕ , described by Folk (1974). The grain-size analyses of most of the sand samples were conducted using a settling tube (Wright and Thornberg 1988). For some of the samples containing significant amount of gravel

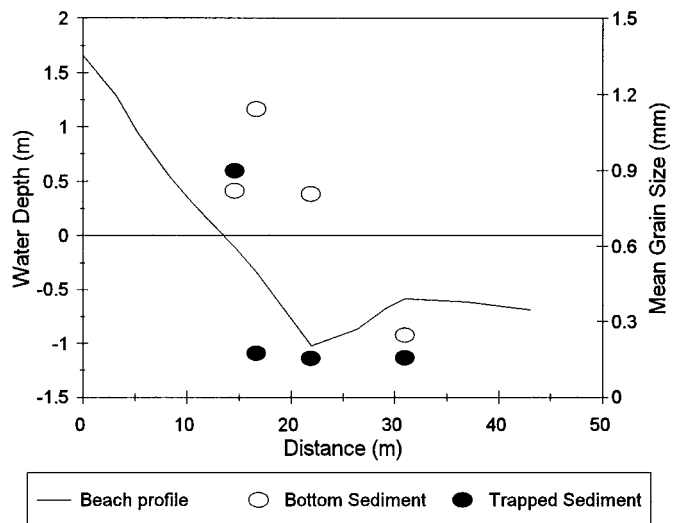

Fig. 6.—Cross-shore distribution of mean grain size of bottom and trapped sediment. The coarse sediment in the trough bottom is believed to be relict from a storm two weeks before sampling, Redington Beach, Florida.

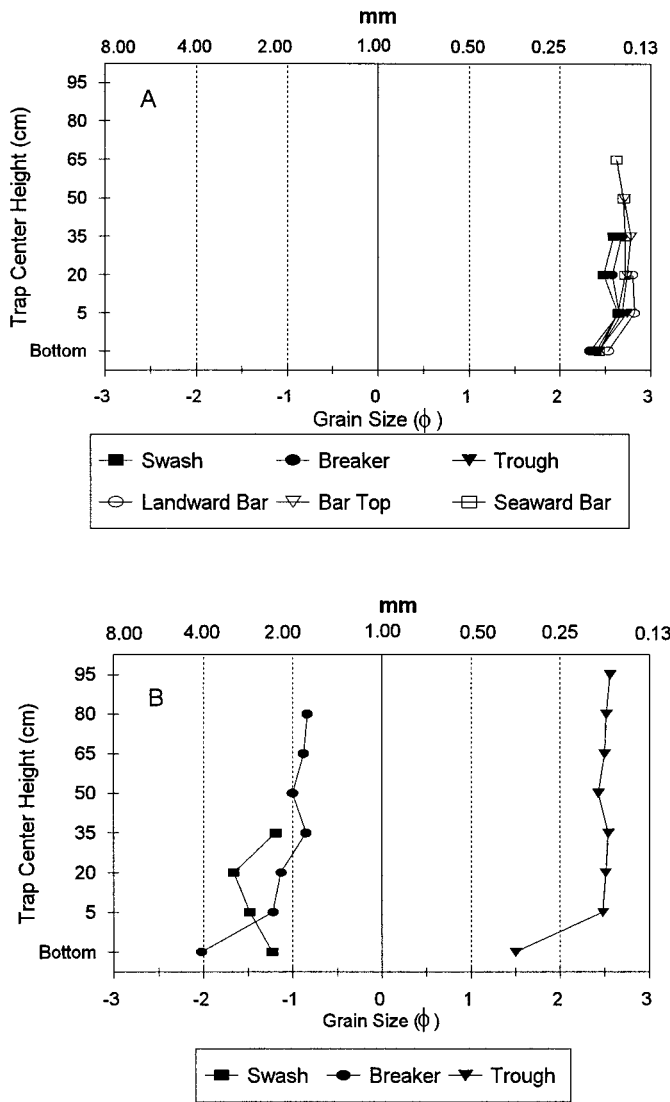

FIG. 7.—Homogeneous profile of mean grain size in the water column: A) uniform beach, Anastasia Beach, Florida, and B) nonuniform beach, Onslow Beach, North Carolina; the sediment in the swash and at the breaker line is much coarser than the sediment in the trough. Notice that the bottom sediment is generally coarser than the sediment in motion.

grains, especially shell debris, with sediment size ranging from up to -4ϕ (16 mm) to 4ϕ (0.063 mm), a combination of sieving and settling was used (Bland and Davis 1988; Sussko and Davis 1992; Davis et al. 1992b; Davis et al. 1993). Carbonate grains, especially in the fractions coarser than medium sand, in the studied sediments were mainly platy shell debris from bivalves. The concentration of carbonate grains in the sediment was used as an indicator of the general shape, i.e., platy or spherical, of the sediment. To obtain information on selective transport of platy shell debris, the carbonate (all shell debris) concentration of 54 sediment samples, both bottom and trapped, from the west-central Florida coast (Sites 13 and 28, Fig. 1), was examined at $1-\phi$ intervals. The sediments were sieved into $1-\phi$ fractions, and the carbonate concentrations were analyzed at each size fraction. Regional mean values of sediment mean grain size, such as average mean grain size across the surf zone and throughout the water column, were calculated using the linear millimeter unit because the log-normal distribution pattern used in the standard grain-size analysis cannot be justified for regional distribution of mean grain sizes.

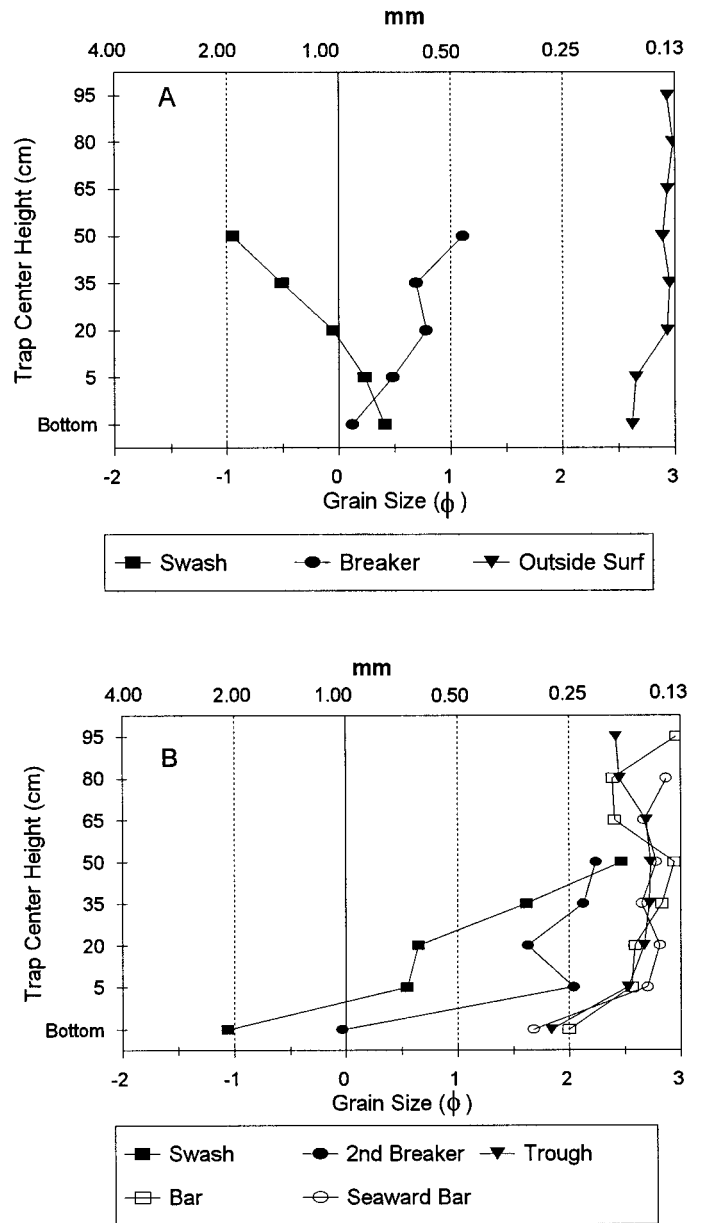

FIG. 8.—Irregular upward-increasing (A: Indian Rocks Beach, Florida) and upward-decreasing (B: Lido Key, Florida) profiles of mean grain size. Notice that both the irregular cases occurred in the shallow shelly swash zone.

The existence of platy shell debris significantly complicated the analysis and comparison of grain size. The definition of grain size and conventional grain-size analysis techniques, both settling and sieving, do not identify directly the influence of grain shape in a large sample. Detailed grain shape analyses, mostly two-dimensional, are time consuming and are typically conducted in studies independently of grain-size statistics (e.g., Mazzullo et al. 1986; Wang and Li 1992). Bland and Davis (1988) and Davis et al. (1992b) found that, for west-central Florida coasts, carbonate concentration is an informative qualitative indicator of the influence of platy shell debris. A uniform grain-size analysis procedure was followed in the present study to ensure comparability.

The average characteristics of the trapped sediments, such as the overall mean grain size, gravel concentration, and carbonate concentration, are represented by the weighted average of the three to eight samples collected throughout the water column such as

TABLE 2.—Summary of measured vertical profiles of mean grain size in the water column.¹

Morphological Feature	No. of Measured Profiles	Homogeneous ⁵ (%)	Heterogeneous ⁶	
			Up. Decrease (%)	Up. Increase (%)
Swash	27	77	19	4
Breaker line ²	28	100	0	0
Trough ³	9	89	11	0
Bar breaker line	7	100	0	0
Surf bore zone ⁴	9	100	0	0
Outside surf zone	6	100	0	0
Overall	86	92	7	1

¹ 13 of the 99 profiles, mostly sampled in the trough, landward side of bar, and outside surf zone, are not included in this table. Not enough sediment, especially more than 20 cm above the sea bed, was collected for reliable grain-size analyses.

² Includes secondary breaker line on barred beach but not the breaker line on top of bar.

³ Barred beaches.

⁴ Nonbarred beaches.

⁵ The variation of the mean grain size throughout the water column is within 1- ϕ interval.

⁶ The variation of the mean grain size throughout the water column is greater than 1- ϕ interval.

$$\bar{P} = \frac{\sum_{i=1}^{i=n} W_i P_i}{\sum_{i=1}^{i=n} W_i} \quad [1]$$

where P_i is a certain property of the sediment such as mean grain size (in the units of mm), gravel concentration (%), or carbonate concentration, etc., W_i is the weight of the sediment trapped at level i , and n is the number of vertical samples in the water column. The value was more weighted toward the bottom, especially the bottom-trap samples from the seabed to 9 cm above, because much more sediment was trapped near the bed than in the upper water column (Wang et al. 1998).

RESULTS

The fundamental data for the present study are the 99 vertical profiles of sediment grain size composed of 651 samples, including bottom sediment and sediment trapped at different elevations in the water column, collected at 29 different coastal locations. Grain-size distribution across the surf zone, grain-size distribution profile in the water column, qualitative selective transport information of platy shell debris and spherical quartz grains, and characteristics of bottom sediment and sediment in motion are discussed in the following sections.

Grain-Size Distribution Across the Surf Zone

The cross-shore distribution of sediment grain size is not always uniform (Fig. 4). Fourteen (48%) of the 29 sites were composed of sediments with a cross-shore variation of mean grain size of less than 1 ϕ and can be considered uniform. Fifteen (52%) sites were composed of sediment with a significant cross-shore variation of mean grain size, ranging from 1.0 to 3.5 ϕ (Table 1). The distribution pattern of grain size across the surf zone is determined mainly by the rate of wave-energy dissipation (e.g., Dean 1977, 1991), local balance in the transport energetics (e.g., Inman and Bagnold 1963; Bowen 1980; Bailard and Inman 1981), and sediment supply. Along barrier islands of Florida Gulf coasts, where 66% of the field measurements were conducted, the main siliciclastic sediment supply is well-sorted fine quartz sand (Fig. 5) from the inner continental shelf and from the reworking of coastal sediments (Davis et al. 1992a). Fine quartz sand constitutes most of the beaches with little cross-shore variation of grain size. Coarser carbonate grains (see the section on selective transport for detail), which can produce significant grain-size variation across the surf zone, are either locally biogenic or artificially supplied through beach nourishment projects that commonly borrow sand from ebb-tidal deltas. Along

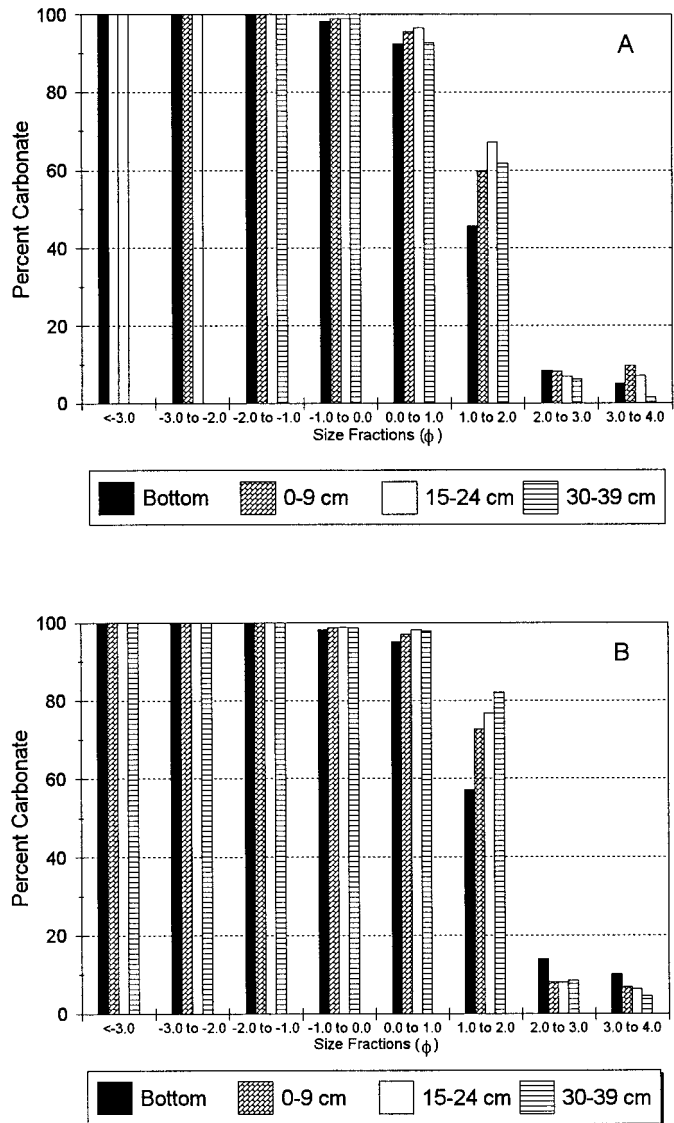

FIG. 9.—Distribution of shell concentration in different size fractions, Indian Rocks Beach, Florida. About 15% more shell debris was found in the 1–2 ϕ size fraction in the trapped sediments; A) swash zone, and B) breaker line.

the Florida Atlantic coast, an additional coarse, shell-rich sediment supply is the erosion of the Anastasia Formation, a cemented, molluscan grainstone (Stauble and McNeill 1985). One measurement was conducted on a gravel beach with a 3.5 ϕ cross-shore variation along Onslow Bay, North Carolina (Site 2, Fig. 1). Unlike most of the Florida sites, the very coarse sand and

TABLE 3.—Summary of carbonate concentration in each size fraction.¹

Size Fraction (ϕ)	Bottom (%)	Trapped (%)
<-3.0	100.0	100.0
-3.0 to -2.0	100.0	100.0
-2.0 to -1.0	100.0	100.0
-1.0 to 0.0	98.1	98.8
0.0 to 1.0	93.4	93.5
1.0 to 2.0	54.4	65.7
2.0 to 3.0	8.5	6.4
3.0 to 4.0	9.0	7.6

¹ To be consistent with the discussion in other sections, the statistics here are based on 28 longshore-directed samples. The cross-shore-directed samples show a similar pattern. The samples were collected in the swash zone, at the breaker line, and on top of the breaker-point bar.

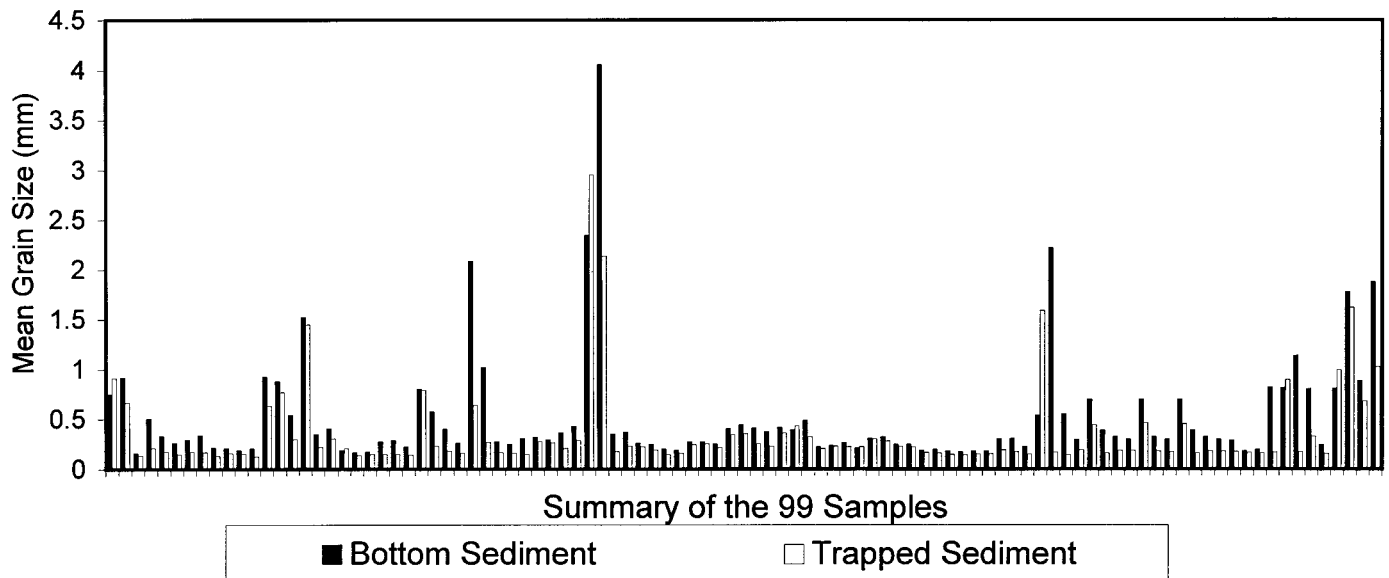

FIG. 10.—Summary of the mean grain size of the 99 bottom sediment samples and the weighted average of the mean grain size of the trapped sediment. Bottom sediment is generally coarser than the trapped sediment. Note the large variation in mean grain size of both bottom and trapped sediments, ranging from 0.2 mm to over 4 mm.

gravel fractions at Onslow Beach are mainly composed of spherical rock debris eroded from the outcrop of the Silverdale Formation exposed near the shoreline (Crowson 1980; Pilkey et al. 1991)

The coarsest sediment is commonly present in the swash zone or at the breaker line, and the finest in the trough (Fig. 4). This situation was first described by Bascom (1951), who found that the coarsest sediment accumulated at the plunge point just seaward of the backrush. Finer sediment tends to be eroded away by the rapid rate of energy dissipation at the breaker line and in the swash zone, leaving coarser material on the bottom. Storm activities and the resulting migration of the offshore bar can leave a layer of coarser lag deposit in the trough where finer sediments are normally located (Fig. 6). Further details on the comparison between bottom sediment and sediment in motion are discussed in the following sections.

Distribution of Sediment Grain Size in the Water Column

Information on sediment suspension and transport processes can be obtained from the vertical distribution of sediment grain size. Previous studies (Kana 1979; Kennedy et al. 1981; Kraus and Dean 1987; Kraus et al. 1988, 1989; Rosati et al. 1990, 1991a) have found the mean grain size to be nearly homogeneous throughout the water column under breaking waves. Kennedy et al. (1981) found that the bottom sediment was coarser than the suspended sediment. A homogeneous profile of grain-size distribution in the water column was also found under non-breaking waves by Nielsen (1983) using suction sampling and by Hay and Sheng (1992) using a multi-frequency backscatter technique. These studies, however, were mostly conducted on fairly well-sorted fine or medium sand beaches with little grain-size variation across the surf zone. In other words, the homogeneous distribution could be determined by the uniform sediment supply rather than the strong mixing induced by breaking waves.

In the present study, a nearly homogeneous vertical distribution of mean grain size, with less than $1-\phi$ variation throughout the water column, was found on most of the beaches (Fig. 7). A homogeneous distribution was also present on the gravel Onslow Beach (Fig. 7B), North Carolina, indicating that the turbulence generated by breaking waves were strong enough to suspend gravel-size particles high into the water column. The homogeneous distribution pattern was found on the bar, at the breaker line, in the trough, in the surf bore area, and in the swash.

The vertical grain-size profiles on some of the shelly beaches along the west-central Florida coasts, which have a cross-shore variation of mean grain size of 2 to 3 ϕ , were more complicated. Although most of the profiles were still homogeneous, both upward-decreasing (Fig. 8B) and upward-increasing grain-size profiles (Fig. 8A) were observed, especially in the shallow swash zone. The measured distribution profiles of mean grain size are summarized in Table 2. Ninety-two percent of the 86 measured mean grain size profiles exhibited a homogeneous distribution. The few heterogeneous vertical distributions with greater than $1-\phi$ vertical variation were measured mainly in the shelly swash zone with high shell concentration. The almost ubiquitous homogeneous grain-size distribution through the water column indicates that the mixing processes in the surf zone are strong enough, even on these coarse, low-energy coasts, to distribute different sizes of suspended sediment evenly throughout the water column.

Selective Transport of Platy Shell Debris

One of the unique features of some of the studied beaches, as compared to previous studies, is the high concentration of platy shell debris from bivalves, especially along the west-central Florida coast. The carbonate concentration of 54 (28 sampled in the longshore direction and 26 in the cross-shore direction) sediment samples, both bottom and trapped, was examined at $1-\phi$ intervals. Almost all the sediments that were coarser than 1ϕ (0.5 mm) were shell debris (Fig. 9). The few, mostly less than 1%, noncarbonate coarse grains are phosphate, which is common along some of the Florida coasts. No terrigenous sediment coarser than 1ϕ (0.5 mm) is available to the area (Davis et al. 1992a).

No difference in carbonate concentrations was found in the fractions coarser than 1ϕ (0.5 mm) in the bottom and trapped sediments at different elevations in the water column (Fig. 9). The nearly identical concentration is controlled by the sediment supply and cannot be used to infer selective transport. The $1.0-2.0 \phi$ (0.50–0.25 mm) fraction contains significant amounts of both quartz and carbonate grains. Examined under a microscope, most of the quartz grains are spherical, whereas most of the shell debris are platy or elongate. About 15% more carbonate grains were found in suspended sediment as trapped by the streamer bags than in the bottom sediment (Fig. 9), indicating that the shell debris is probably more easily

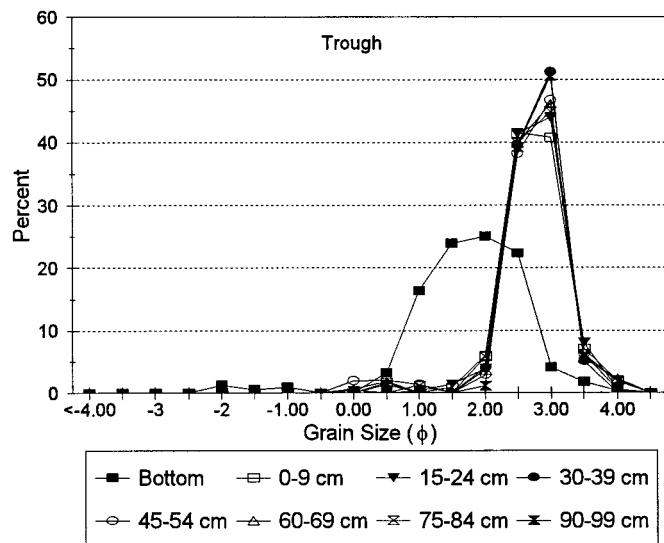
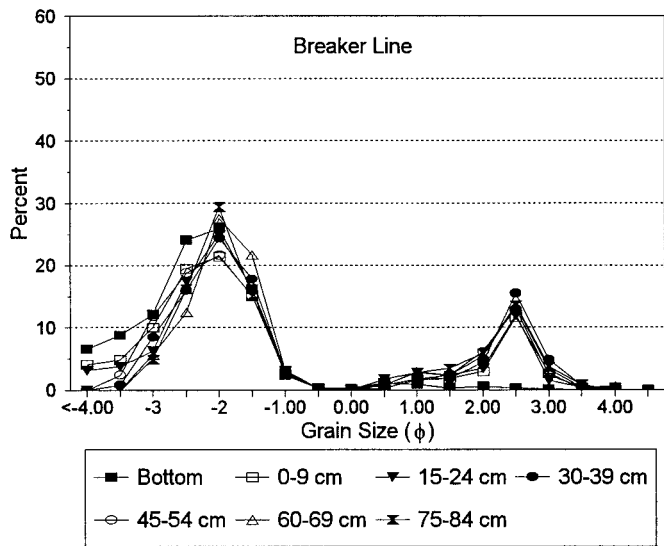
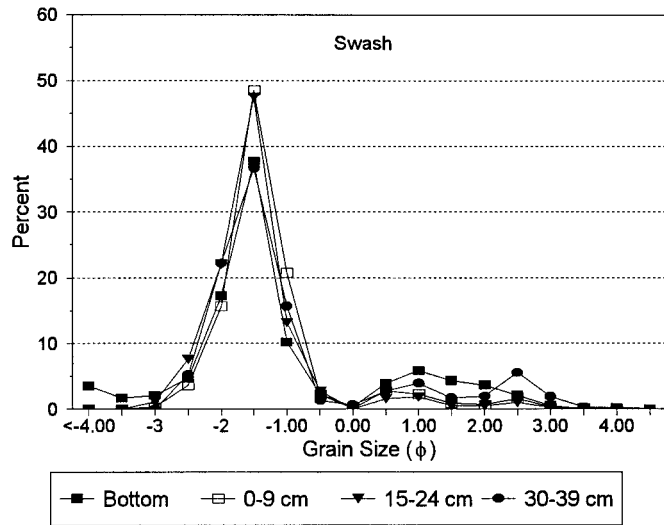

mobilized and transported in the surf zone than spherical quartz grains of the same sieve size.

The overall carbonate concentration in each size fraction for the 28 long-shore-directed samples is summarized in Table 3. The carbonate concentrations are nearly identical in all size fractions except in the 1.0–2.0 ϕ fraction, where an 11.3% difference was measured. No significant difference in shell-debris concentration was found among sediments trapped at different depth levels, which indicates a fairly homogeneous size-mixing processes throughout the water column. Similar conclusions can also be drawn from the homogeneous profiles of sediment grain size.

Grain-Size Distribution Patterns of Bottom Sediment and Sediment in Motion

The mean grain size of the bottom sediment is generally coarser than the weighted average (Eq 1) of the mean grain size of sediment in the water column, i.e., the trapped sediment (Fig. 10). More gravel was found in the bottom sediment than in the trapped sediment. Two exceptions were found in shelly swash zones in the west-central Florida coast, where the trapped sediment was slightly coarser than the bottom sediment, suggesting that platy material is preferentially suspended over spherical material at these two sites. No significant differences in grain-size distribution and grain shape were found between these two samples and other samples with high carbonate concentrations. The abnormal coarser trapped sediment in the two swash zones cannot be readily explained by the time-averaged visual observations of breaking wave height, wave period, and incident wave angle.

The average mean grain size of the 99 bottom sediment samples was 0.52 mm (0.95 ϕ). The average of the 99 overall (weighted average) mean grain size of trapped sediment was 0.36 mm (1.48 ϕ). The bottom sediment was 31% (in millimeter units) coarser than the sediment that was being transported. The average percent gravel concentration was 11.3% for the bottom sediment and 6.9% for the trapped sediment (weighted average). Thirty-nine percent more gravel was found in the bottom sediment. The presence of significant gravel confirms the concept that the larger sediment grains tend to remain on the bottom rather than being lifted into the water column. The properties of the active bottom sediment here represent the average of an 8-cm-thick layer at the sand surface. It is possible that the grain size and its distribution include the influence of relict deposits from previous high-energy events. Sediment grain size is one of the fundamental parameters commonly used in reconstruction of the paleo-environment, and one of the applications is to infer the relative depositional energy level (see summaries by Davis 1985, 1992; Walker and James 1992). The above comparison between bottom sediment and trapped sediment suggests that the paleo-energy level represented by the preserved sediment may be biased by high-energy events.

For the majority of the measurements, no significant differences in mean grain size, standard deviation of grain size, and carbonate concentration were found among sediments collected at different elevation levels. The grain-size distribution patterns of bottom sediment and sediments moving at different elevation levels were also compared (Figs. 11, 12). Identical grain-size distribution patterns were found throughout the water column for most of the measured profiles on both well-sorted fine sand beaches (Fig. 12) and poorly sorted gravel beaches (Fig. 11). The homogeneous vertical profile indicates that the vertical mixing mechanism in the surf zone is independent of sediment grain size and its distribution. Significant amounts

←
FIG. 11.—Nearly identical grain-size distribution pattern of the poorly sorted gravel and sand throughout the water column at the swash, breaker line, and trough, Onslow Beach, North Carolina. More coarse fractions were generally found in the bottom sediment, especially in the trough.

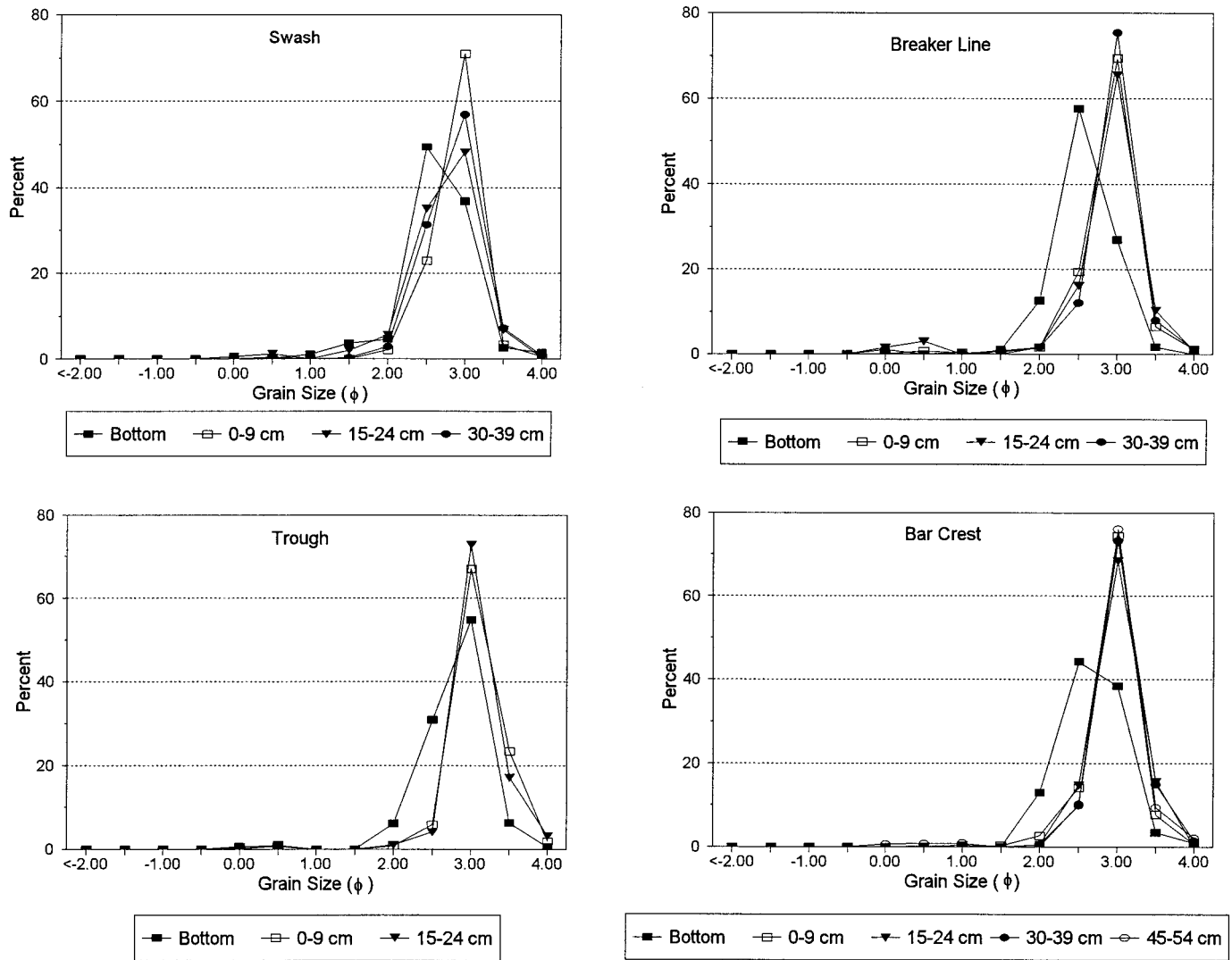

FIG. 12.—Nearly identical grain-size distribution patterns of well-sorted fine sand at the swash, breaker line, trough, and bar crest, Anastasia Beach, Florida. Higher contents of coarse fractions were found in the bottom sediment.

of spherical grains, as large as 2 cm in diameter, were suspended to above 15 cm from the bed at the breaker line (Fig. 11), indicating a strong upward convective process (Nielsen 1983, 1991) for sediment suspension in the surf zone.

SUMMARY AND CONCLUSIONS

This field data-collection effort yielded 99 vertical profiles from 651 sediment samples taken on 29 beaches, from which the grain-size distribution could be analyzed across the surf zone and through the water column. The sediment sampling was conducted on beaches composed of a variety of sediment textures, ranging from well-sorted fine quartz sand to poorly sorted shelly gravel. The coarsest sediments were generally found in the swash zone and at the wave breaker line, and the finest sediments were usually found in the relatively low-wave-energy trough located landward of the breaker bar.

Bottom sediment was generally coarser than trapped sediment, with greater gravel content than the sediment that was being transported in the water column, indicating that the coarse sediment tends to remain on the bottom. Storms and the resulting migration of the offshore bar could leave

a layer of coarser lag deposits where finer sediment would normally be located.

Along the shelly beaches on the west-central Florida coast, almost all the sediments coarser than 1ϕ (0.50 mm) are shell debris, controlled by local sediment supply. More shell debris was found in the medium sand fraction in the trapped sediment than in the medium sand fraction in the bottom sediment. The greater concentration of platy and elongate shell debris indicates that shell debris is more easily transported in the water column than spherical quartz grains of the same sieve size.

The vertical profiles of both mean grain size and distribution pattern of grain size in the water column were homogeneous, with less than $1-\phi$ variation, for a wide range of sediment grain sizes and textures on most of the studied beaches. A homogeneous vertical distribution of grain size was found at all major morphological features: swash zone, breaker line, mid-surf zone, trough, and bar. The few exceptions were found in some of the shelly swash zones on beaches with large cross-shore grain-size variation, especially on reflective beaches under collapsing breakers, where both upward-increasing and upward-decreasing mean grain-size profiles were observed. The ubiquity of the homogeneous vertical profile indicates that the vertical mixing mechanism through the water column in the surf zone is

independent of sediment size and size distribution, suggesting homogeneous mixing by saturation of turbulence and large-scale convective eddies under breaking and broken waves.

ACKNOWLEDGMENTS

This study was partly funded by Pinellas County, Florida. The authors would like to thank the graduate students in the Coastal Research Laboratory at the University of South Florida (USF) for their assistance in the field work. Mr. Sam Valenti at the USF machine shop is acknowledged for his help during the construction of the streamer traps. We are grateful to Drs. Bruce Jaffe, Robin Davidson-Arnott, Patricia Wiberg, Gail Ashley, and an anonymous reviewer for a critical and helpful review of this paper. N.C. Kraus appreciates permission given by Headquarters, U.S. Army Corps of Engineers, to participate in publication of this information. P. Wang appreciates the support of Dr. Gregory Stone at Louisiana State University.

REFERENCES

- AGRAWAL, Y.C., POTTSMITH, H.C., LYNCH, J., AND IRISH, J., 1996, Laser instruments for particle size and settling velocity measurements in the coastal zone: *Oceans '96*, Marine Technology Society/Institute of Electrical and Electronic Engineers, Ft. Lauderdale, Florida, Proceedings, p. 1-8.
- BALLARD, J.A., AND INMAN, D.L., 1981, An energetics bedload model for a plane sloping beach: local transport: *Journal of Geophysical Research*, v. 86, p. 2035-2043.
- BARKASZI, S.F., AND DALLY, W.R., 1992, Fine-scale measurement of sediment suspension by breaking waves at SUPERTANK: American Society of Civil Engineers, 23rd Coastal Engineering Conference, Proceedings, p. 1910-1923.
- BASCOM, W.N., 1951, The relationship between sand size and beach-face slope: *American Geophysical Union, Transactions*, v. 32, p. 866-874.
- BLAND, M.J., AND DAVIS, R.A., JR., 1988, Sedimentary environments within Little Sarasota Bay, Florida: *Journal of Coastal Research*, v. 4, p. 279-288.
- BOWEN, A.J., 1980, Simple models of nearshore sedimentation: Beach profiles and longshore bars, in McCann, S.B., ed., *The Coastline of Canada: Littoral Processes and Nearshore Bars: Geological Survey of Canada, Ottawa, Ontario*, p. 1-11.
- COAKLEY, J.P., SAVILE, H.A., PEDROSA, M., AND LAROQUE, M., 1978, Sled system for profiling suspended littoral drift: American Society of Civil Engineers, 16th Coastal Engineering Conference, Proceedings, p. 1764-1775.
- CRAWFORD, A.M., AND HAY, A.E., 1993, Determining suspended sand size and concentration from multifrequency acoustic backscatter: *Acoustical Society of America, Journal*, v. 96, p. 3312-3324.
- CROWSON, R.A., 1980, Nearshore rock exposures and their relationship to modern shelf sedimentation, Onslow Bay, North Carolina [unpublished M.S. Thesis]: East Carolina University, Greenville, North Carolina, 128 p.
- DAVIS, R.A., JR., ED., 1985, *Coastal Sedimentary Environments*: New York, Springer-Verlag, 716 p.
- DAVIS, R.A., JR., 1992, *Depositional Systems*: Englewood Cliffs, New Jersey, Prentice Hall, 604 p.
- DAVIS, R.A., JR., 1996, *Coasts*: Englewood Cliffs, New Jersey, Prentice Hall, 274 p.
- DAVIS, R.A., JR., HINE, A.C., AND SHINN, E.A., 1992a, Holocene coastal development of the Florida Peninsula, in Fletcher, C.H., III, and Wehmiller, J.F., eds., *Quaternary Coasts of the United States: Marine and Lacustrine Systems: SEPM, Special Publication 48*, p. 193-213.
- DAVIS, R.A., JR., INGLIN, D.C., GIBEAUT, J.C., CREASER, G.J., HANEY, R.L., AND TERRY, J.B., 1993, Performance of three adjacent but different beach nourishment projects, Pinellas County, Florida: American Society of Civil Engineers, Coastal Zone '93, Proceedings, p. 379-389.
- DAVIS, R.A., JR., KLAY, J., AND JEWELL, P., 1992b, Sedimentology and stratigraphy of tidal sand ridges southwest Florida inner shelf: *Journal of Sedimentary Petrology*, v. 63, p. 91-104.
- DEAN, R.G., 1977, Equilibrium beach profiles: U.S. Atlantic and Gulf coasts: *Ocean Engineering*, University of Delaware, Newark, Delaware, Report No. 12, 45 p.
- DEAN, R.G., 1991, Equilibrium beach profiles: Characteristics and applications: *Journal of Coastal Research*, v. 7, p. 53-84.
- FAIRCHILD, J.C., 1965, A tractor-mounted suspended sand sampler: *Shore and Beach*, v. 33, p. 31-34.
- FAIRCHILD, J.C., 1977, Suspended sediment in the littoral zone at Ventnor, New Jersey and Nags Head, North Carolina: US Army Corps of Engineers, Coastal Engineering Research Center, Technical Paper 77-5, 97 p.
- FOLK, R.L., 1974, *Petrology of Sedimentary Rocks*: Austin, Texas, Hemphill Publishing Company, 182 p.
- GREENWOOD, B., OSBORNE, P.D., AND BOWEN, A.J., 1991, Measurements of suspended sediment transport: prototype shorefaces: American Society of Civil Engineers, Coastal Sediments '91, Proceedings, p. 284-299.
- HAY, A.E., AND SHENG, J., 1992, Vertical profiles of suspended sand concentration and size from multifrequency acoustic backscatter: *Journal of Geophysical Research*, v. 97, p. 15,661-15,677.
- HORIKAWA, K., ED., 1988, *Nearshore Dynamics and Coastal Processes: Theory, Measurement, and Predictive Models*: University of Tokyo Press, Tokyo, 522 p.
- INMAN, D.L., AND BAGNOLD, R.A., 1963, Littoral processes, in Hill, M.N., ed., *The Sea*: New York, Wiley-Interscience, p. 529-533.
- KANA, T.W., 1979, *Suspended sediment in breaking waves*: University of South Carolina, Columbia, South Carolina, Department of Geology, Technical Report 18-CRD, 153 p.
- KENNEDY, S.K., EHRLICH, R., AND KANA, T.W., 1981, The non-normal distribution of intermittent suspension sediments below breaking waves: *Journal of Sedimentary Petrology*, v. 51, p. 1103-1108.
- KOMAR, P.D., AND REIMERS, C.E., 1978, Grain shape effects on settling rates: *Journal of Geology*, v. 86, p. 193-209.
- KRAUS, N.C., 1987, Application of portable traps for obtaining point measurement of sediment transport rates in the surf zone: *Journal of Coastal Research*, v. 2, p. 139-152.
- KRAUS, N.C., AND DEAN, J.L., 1987, Longshore sediment transport rate distributions measured by trap: American Society of Civil Engineers, Coastal Sediments '87, Proceedings, p. 818-896.
- KRAUS, N.C., GINGERICH, K.J., AND ROSATI, J.D., 1988, Toward an improved empirical formula for longshore sand transport: American Society of Civil Engineers, 21st Coastal Engineering Conference, Proceedings, p. 1183-1196.
- KRAUS, N.C., GINGERICH, K.J., AND ROSATI, J.D., 1989, Duck85 surf zone sand transport experiment: US Army Corps of Engineers, Waterways Experiment Station, Coastal Engineering Research Center, Vicksburg, Mississippi, Technical Report CERC-89-5, 48 p.
- MEHTA, A.J., LEE, J., LEE, A.H., AND CHRISTENSEN, B.A., 1980, Fall velocity of shells as coastal sediment: American Society of Civil Engineers, Journal of the Hydraulics Division, v. 106, p. 1727-1744.
- MAZZULLO, J., SIMS, D., AND CUNNINGHAM, D., 1986, The effects of eolian sorting and abrasion upon the shapes of fine quartz sand grains: *Journal of Sedimentary Petrology*, v. 56, p. 45-56.
- NIELSEN, P., 1983, Entrainment and distribution of different sand sizes under water waves: *Journal of Sedimentary Petrology*, v. 53, p. 423-428.
- NIELSEN, P., 1984, Field measurements of time-averaged suspended sediment concentrations under waves: *Coastal Engineering*, v. 8, p. 51-72.
- NIELSEN, P., 1991, Combined convection and diffusion: a new framework for suspended sediment modeling: American Society of Civil Engineers, Coastal Sediments '91, Proceedings, p. 419-431.
- PILKEY, O.H., YOUNG, R.S., RIGGS, S.R., SMITH, A.W.S., WU, H., AND PILKEY, W.D., 1991, The concept of shoreface profile of equilibrium: A critical review: *Journal of Coastal Research*, v. 9, p. 255-278.
- ROSATI, J.D., AND KRAUS, N.C., 1988, Hydraulic calibration of the streamer trap: *Journal of Hydraulic Engineering*, v. 114, p. 1527-1532.
- ROSATI, J.D., GINGERICH, K.J., AND KRAUS, N.C., 1990, SUPERDUCK surf zone sand transport experiment: U.S. Army Corps of Engineers, Waterways Experiment Station, Coastal Engineering Research Center, Vicksburg, Mississippi, Technical Report CERC-90-10, 50 p.
- ROSATI, J.D., GINGERICH, K.J., AND KRAUS, N.C., 1991a, East pass and Ludington sand transport data collect project: data report: U.S. Army Corps of Engineers, Waterways Experiment Station, Coastal Engineering Research Center, Vicksburg, Mississippi, Technical Report CERC-91-3, 13 p.
- ROSATI, J.D., GINGERICH, K.J., KRAUS, N.C., SMITH, J.M., AND BEACH, R.A., 1991b, Longshore sand transport rate distributions measured in Lake Michigan: American Society of Civil Engineers, Coastal Sediments '91, Proceedings, p. 156-170.
- STAUBLE, D.K., AND MCNEILL, D.F., 1985, Coastal geology and the occurrence of beachrock: central Florida Atlantic coast: Field Guide: Geological Society of America, 1985 Annual Meeting, 2 parts, 41 p.
- SUSSKO, R.J., AND DAVIS, R.A., JR., 1992, Siliciclastic-to-carbonate transition on the inner shelf embayment, southwest Florida: *Marine Geology*, v. 107, p. 51-60.
- WALKER, R.G., AND JAMES, N.P., 1992, Facies Models: Geological Association of Canada, Ontario, 409 p.
- WANG, P., 1995, Surf zone sediment transport on low energy coasts: field measurement and prediction [unpublished Ph.D. thesis]: University of South Florida, Tampa, Florida, 235 p.
- WANG, P., 1998, Longshore sediment flux in the water column and across the surf zone: American Society of Civil Engineers, Journal of Waterway, Port, Coastal, and Ocean Engineering, in press.
- WANG, P., AND DAVIS, R.A., JR., 1994, Field measurement of longshore sediment transport in the surf zone: Florida Shore and Beach Preservation Association, 1994 National Conference on Beach Preservation Technology, Proceedings, p. 413-428.
- WANG, P., AND LI, C., 1992, Roundness parameters in barrier-lagoon systems in northeastern Shandong Peninsula, China: limitations to environmental discrimination: *Sedimentary Geology*, v. 77, p. 143-152.
- WANG, P., KRAUS, N.C., AND DAVIS, R.A., JR., 1998, Total longshore sediment transport rate in the surf zone: field measurements and empirical predictions: *Journal of Coastal Research*, v. 14, p. 269-282.
- WATTS, G.M., 1953, Development and field tests of a sampler for suspended sediment in wave action: US Army Corps of Engineers, Beach Erosion Board, Technical Memorandum 34, 41 p.
- WRIGHT, R., AND THORNBERG, S.M., 1988, SEDIDAT: A BASIC program for the collection and statistical analysis of particle settling velocity data: *Computers and Geosciences*, v. 14, p. 55-81.
- ZAMPOL, J.A., AND INMAN, D.L., 1989, Suspended sediment measurements; A. Discrete measurement of suspended sediment, in Seymour, R.J., ed., *Nearshore Sediment Transport*: New York, Plenum, p. 259-272.
- ZAMPOL, J.A., AND WALDORF, B.W., 1989, Measuring sediment dynamics; A. Discrete sampling of bedload and suspended load, in Seymour, R.J., ed., *Nearshore Sediment Transport*: New York, Plenum, p. 79-89.

Received 21 March 1996; accepted 23 December 1997.